

View "A" (A_00050-TS1)
With Tool shaft "TS"

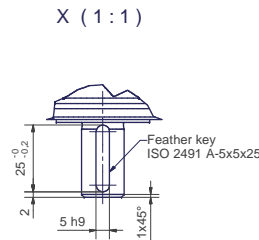

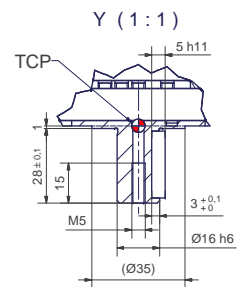

View "A" (A_00050-T1)
With Tool flange "T"

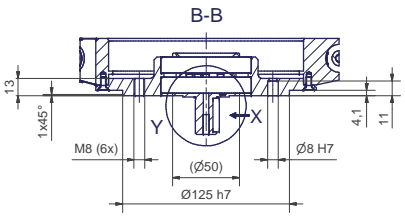
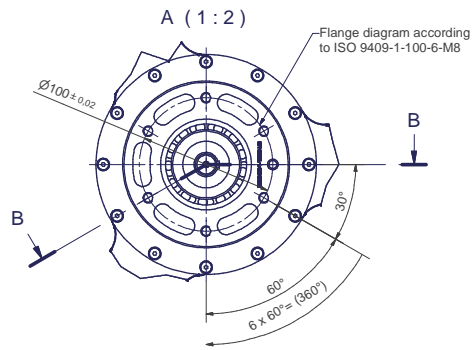
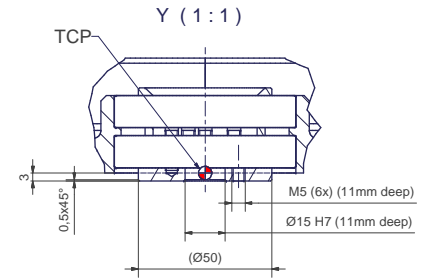
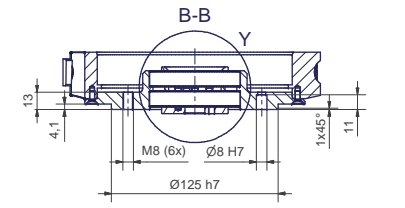
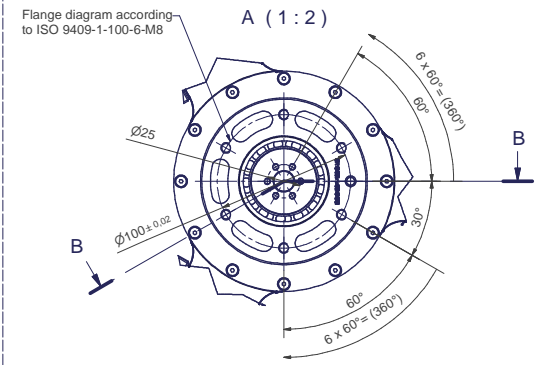

m= kg	A	ρ = bar
projected storage surface = m²	P= kW	\dot{V} = l/min
U= V / Hz / Ph	I _{max} = A	

12 11 10 9 8 7 6 5 4 3 2 1

-  All fastening holes $\varnothing 17,5\text{mm}$ for screws M16 (DIN ISO 4014/4017 -8.8) without washer. Fastening holes are coloured red.
-  Fastening holes filled blue are difficult to access. We recommend using fastening holes coloured red.
-  Drilling holes for locating pins are filled red.

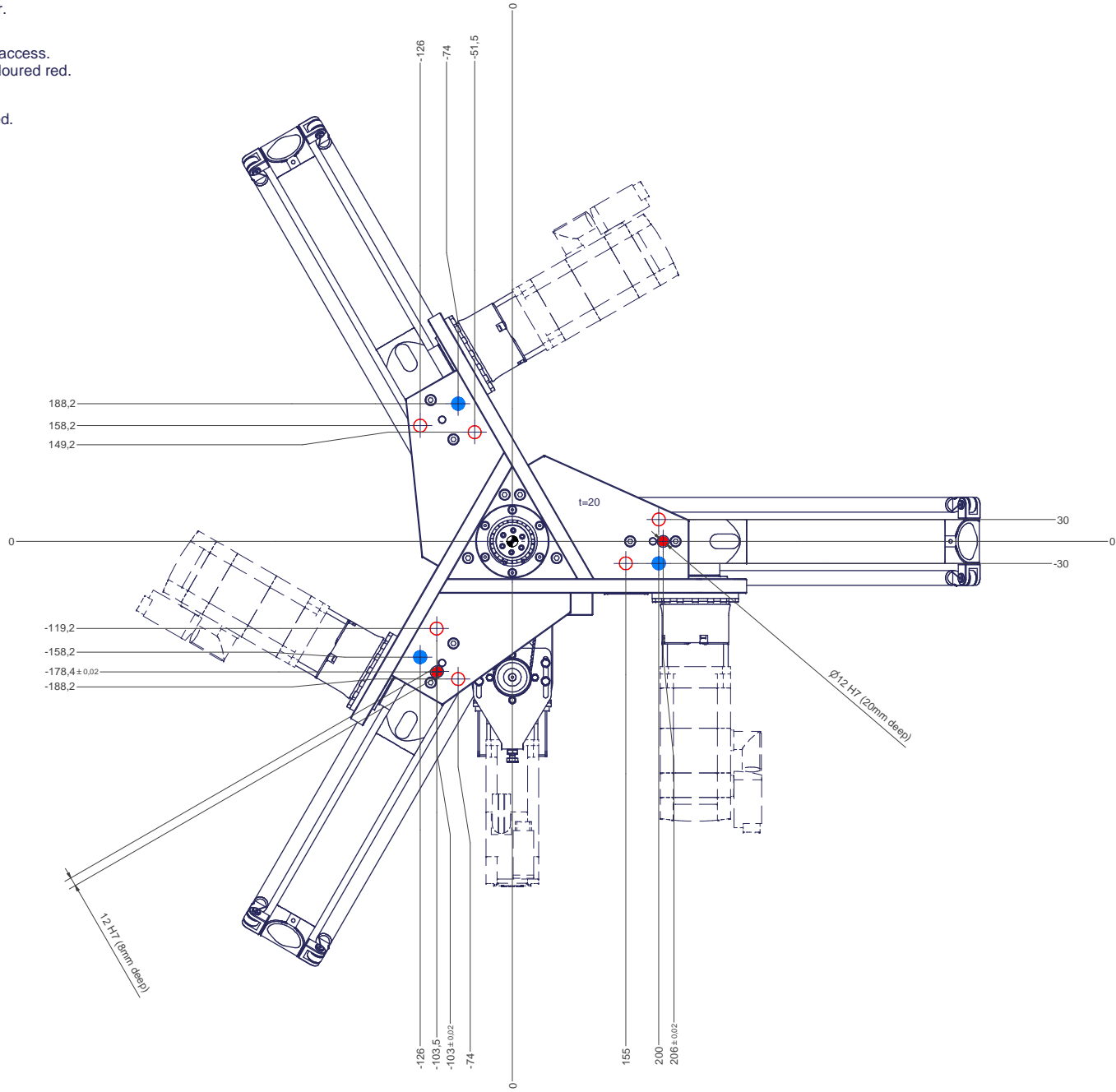

12 11 10 9 8 7 6 5 4 3 2 1