

HHD DELTA RL3-1200-3kg

Article number: A_00894-FO

Lubricant variant: Food-grade lubricants (FO)

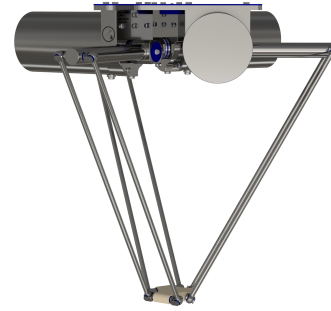

Description:

This type of robot is based on the principle of parallel kinematics. All drives are mounted in a fixed position on the robot head. Motor cables are not moved. The robot has three (3) translational of freedom.

Scope of delivery:

Robot mechanics incl. gearbox, Servo motor adapter, Transport and packing instructions

Connecting dimensions:

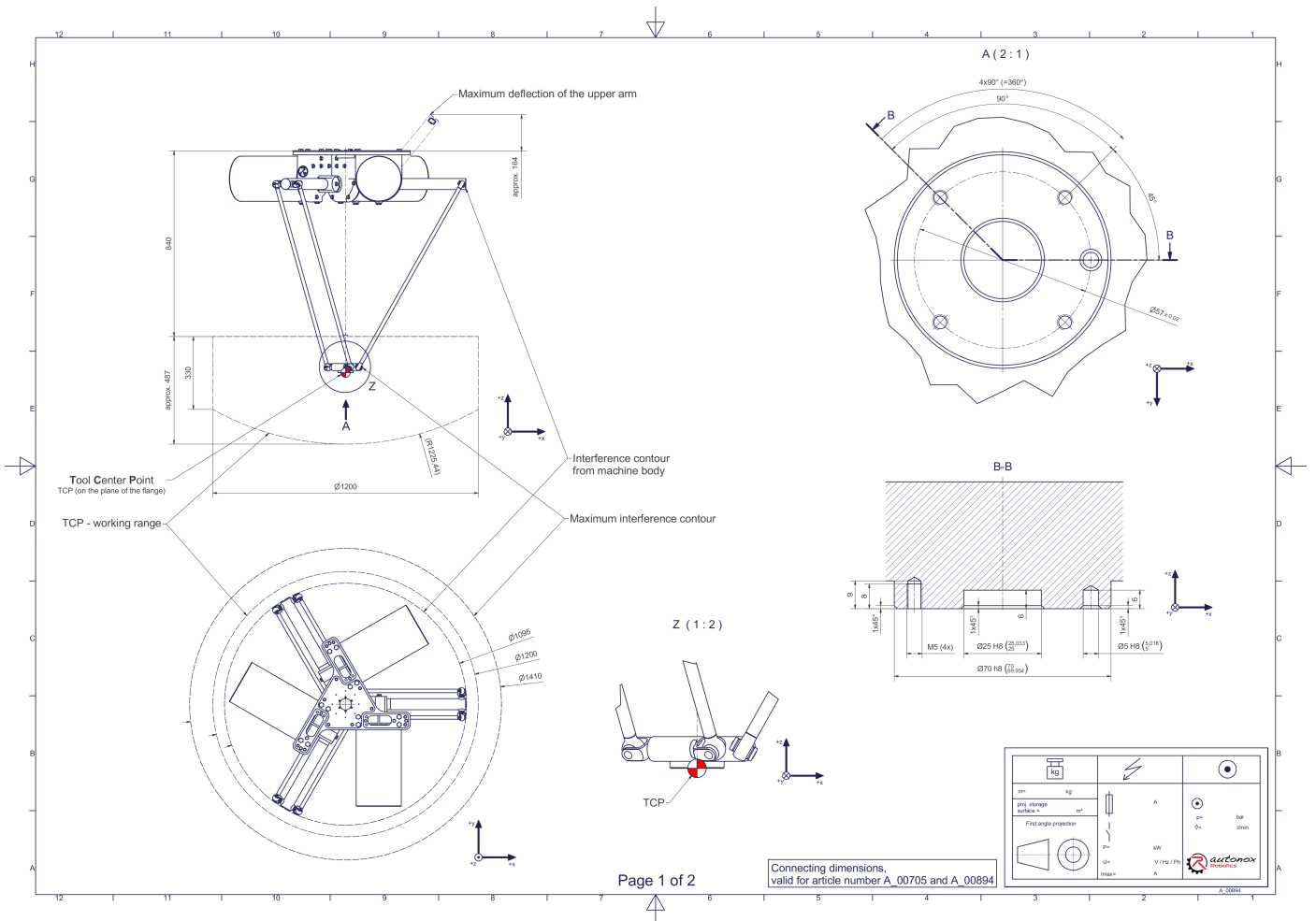

Downloads: [Connecting dimensions \(PDF\)](#), [3D model \(STP\)](#), [3D model \(PDF\)](#)

We refer to our [General Terms of Sale and Supply](#), [Terms of use](#) and [Disclaimer and Copyright notices](#).

Technical specifications:

Field of application	Hygienic 'HHD'
Kinematics	Parallel
Translatory Degrees of Freedom (X,Y,Z)	3
Rotational Degrees of Freedom (α,β,γ)	0
Nominal payload [kg lbs] *	3 6.6
Working area-diameter [mm in]	1200 47.2
Working height outside [mm in]	330 13.0
Working height center [mm in]	487 19.2
Bearing type of the arm joints	Roller bearing
Lubricants of the bearings	Food-grade (FO)
Lubricants of the gearboxes	Food-grade (FO)
Cleaning	Up to 28 bar 406 psi high pressure
Protection class	IP69K
Ambient temperature [°C °F]	0 to +40 +32 to +104
Relative humidity level [%]	95 (free of condensation)
Mounting position	Floor, Ceiling, Wall (on request), Angle (on request)

* All given values are nominal values (nominal payload referred to a nominal performance) and can vary under realworld conditions depending on the application (tool specifications, load distances, reduction (partly) of the nominal performance when using food-grade lubricants, ...). Please consider our technical data sheets regarding the load capacity.