

DELTA RL4-600-1kg

Article number: A_00082-04-FO

Lubricant variant: Food-grade lubricants (FO)



Description:

This type of robot is based on the principle of parallel kinematics. All drives are mounted in a fixed position on the robot head. Motor cables are not moved. The robot has three (3) translational and one (1) rotational degree(s) of freedom.

Scope of delivery:

Robot mechanics incl. gearbox, Servo motor adapter, Threaded protection caps, Transport and packing instructions

Connecting dimensions:

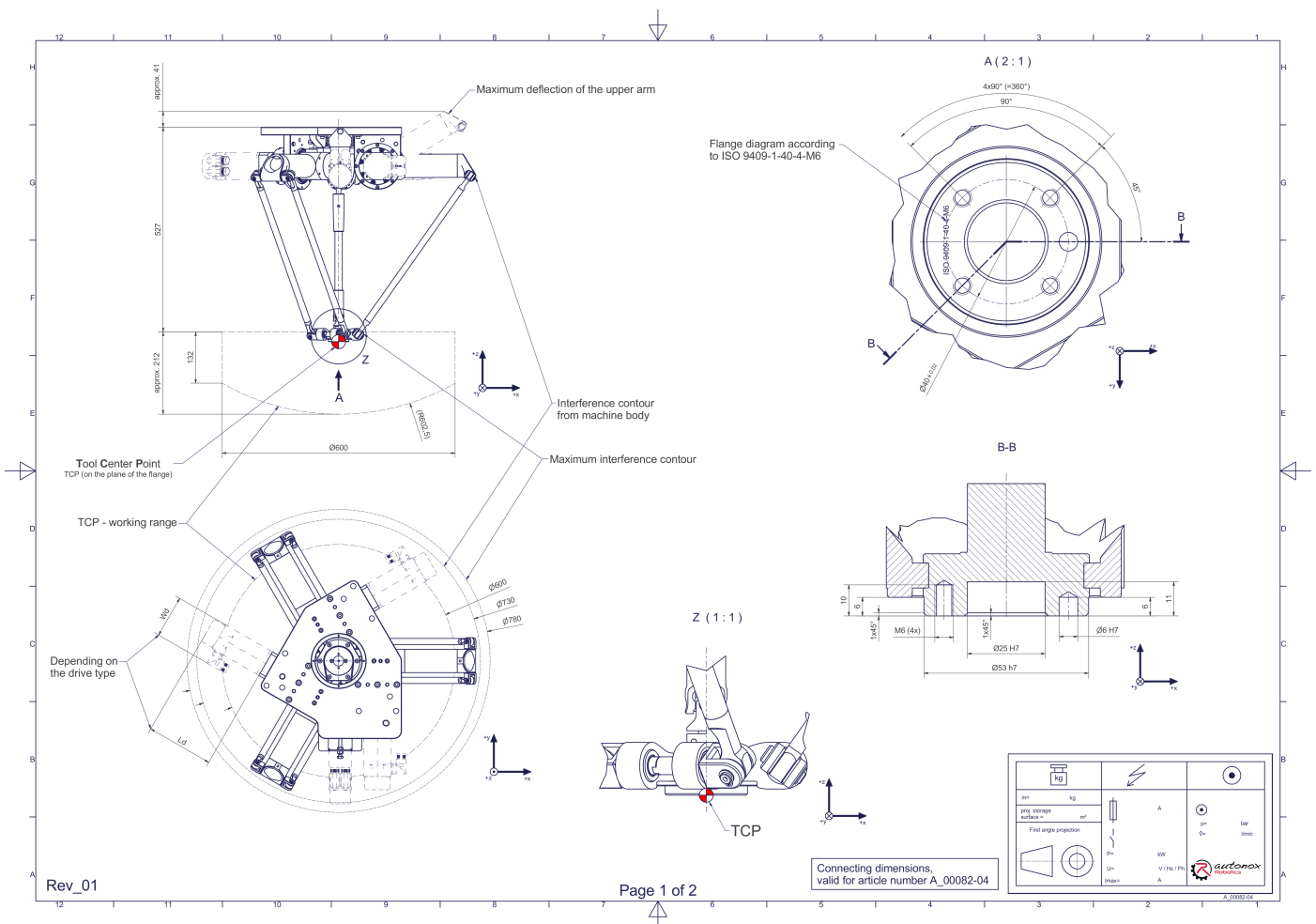

Downloads: [Connecting dimensions \(PDF\)](#), [3D model \(STP\)](#), [3D model \(PDF\)](#)

We refer to our [General Terms of Sale and Supply](#) and [Terms of use](#).

Technical specifications:

Field of application	Standard (not hygienic)
Kinematics	Parallel
Translatory Degrees of Freedom (X,Y,Z)	3
Rotational Degrees of Freedom (α,β,γ)	1
Nominal payload [kg lbs] *	1 2.2
Working area-diameter [mm in]	600 23.6
Working height outside [mm in]	132 5.2
Working height center [mm in]	212 8.3
Max. acceleration torque of the rotation γ around Z at the output [Nm in.lbs]	7,2 63.7
Nominal torque of the rotation γ around Z at the output [Nm in.lbs]	7,2 63.7
Max. speed of the rotation γ around Z at the output [1/min]	500
Nominal speed of the rotation γ around Z at the output [1/min]	320
Bearing type of the telescopic shaft(s)	Roller bearing
Bearing type of the arm joints	Roller bearing
Lubricants of the bearings	Food-grade (FO)
Lubricants of the gearboxes	Food-grade (FO)
Cleaning	No high pressure
Ambient temperature [$^{\circ}$C $^{\circ}$F]	0 to +40 +32 to +104
Relative humidity level [%]	95 (free of condensation)
Mounting position	Floor, Ceiling, Wall (on request), Angle (on request)
Special features	All drives (gearbox, reduction gearing, ...) are located below the head plate. Advantages: Easily accessible, easy to maintain, compact

* All given values are nominal values (nominal payload referred to a nominal performance) and can vary under realworld conditions depending on the application (tool specifications, load distances, reduction (partly) of the nominal performance when using food-grade lubricants, ...). Please consider our technical data sheets regarding the load capacity.